

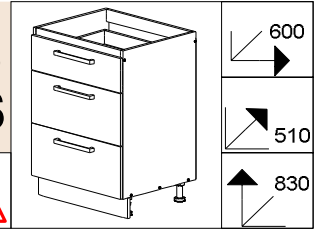

# NOVA PLUS NOPL-058-0S



V PRÍPADE REKLAMÁCIE JE POTREBNÉ NAHLÁSIŤ  
 VÝROBNÉ ČÍSLO VIDITEĽNÉ NA ETIKETE



A 22x	B 8x	C 30x	D 18x	E 3x	F 10x	G 3x	H 24x	I 24x	J 24x



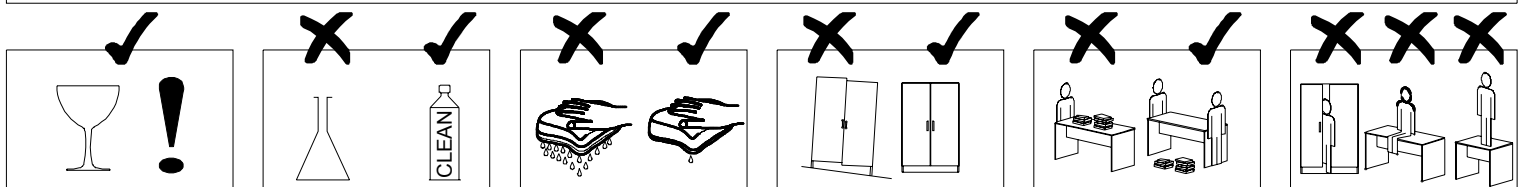
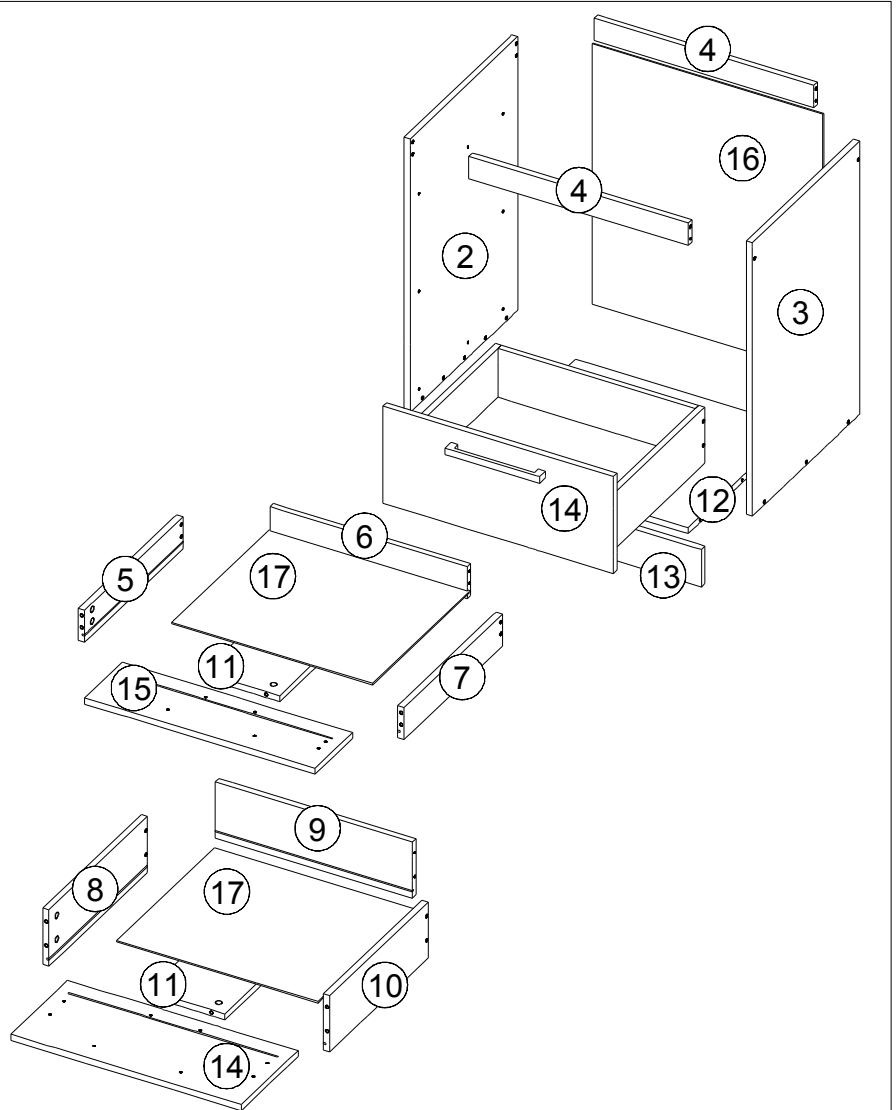

K 4x	L 2x	M 4x	N 9x	P 24x

0h 55min			3m	4		≤ 0,5 kg

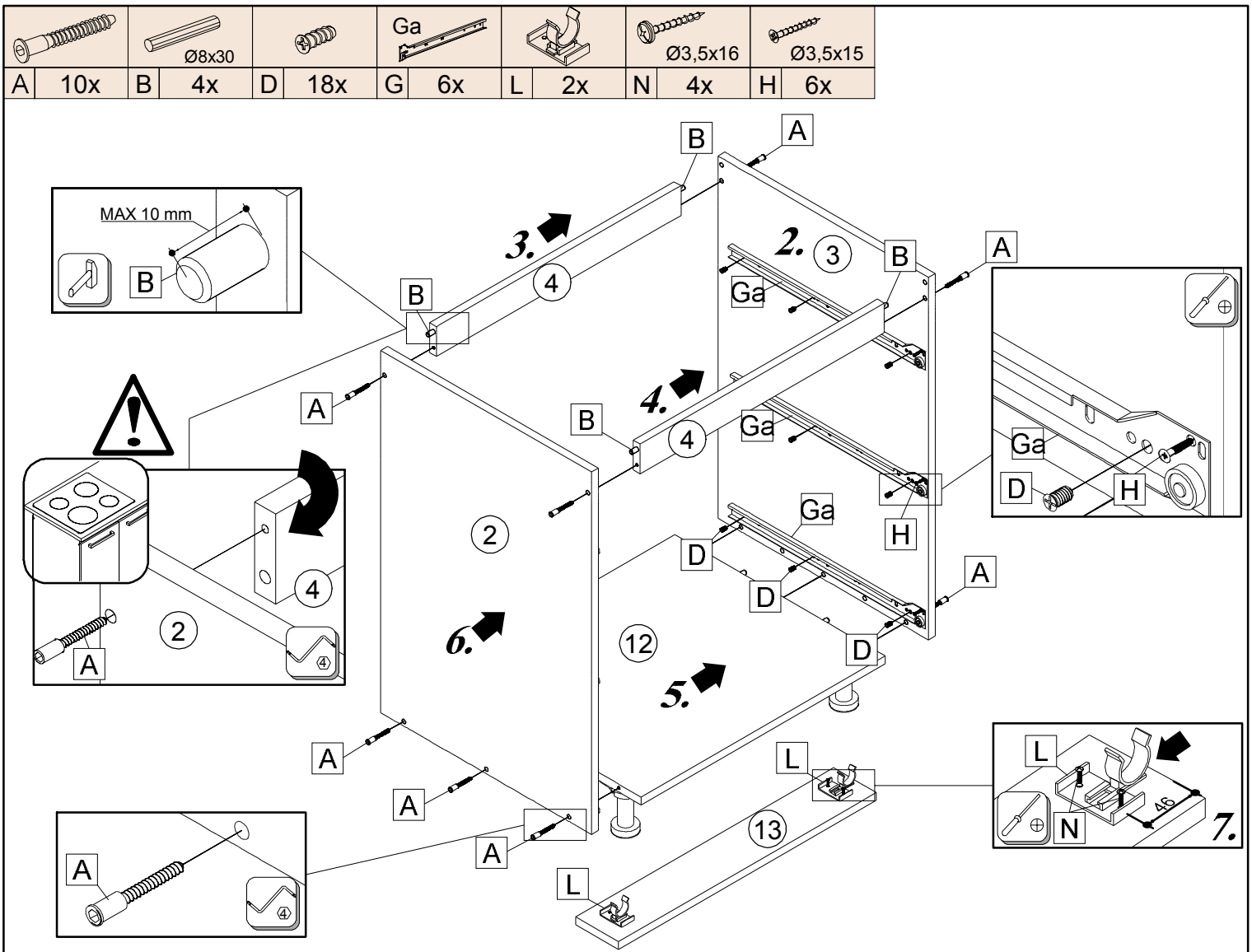
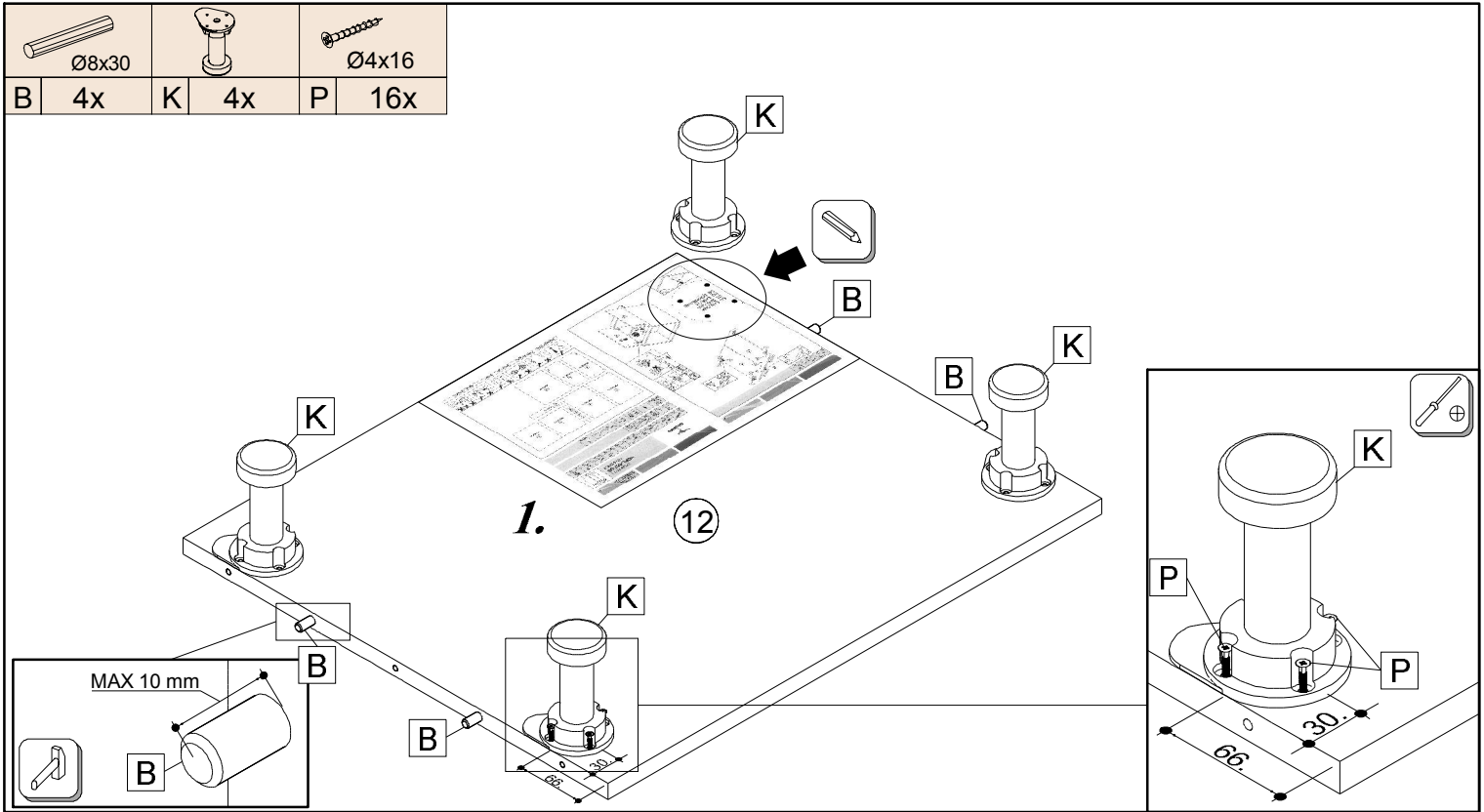



ID	ID	Part	Qty	Ratio
00371	②	730*490*16	1x	1/1
00372	③	730*490*16	1x	1/1
00398	④	568*60*16	2x	1/1
00362	⑤	450*85*16	1x	1/1
00374	⑥	510*85*16	1x	1/1
00364	⑦	450*85*16	1x	1/1
00375	⑧	450*150*16	2x	1/1
00376	⑨	510*150*16	2x	1/1
00377	⑩	450*150*16	2x	1/1
00378	⑪	433*200*16	3x	1/1
00400	⑫	568*489*16	1x	1/1
00401	⑬	600*100*16	1x	1/1
00381	⑭	596*259*16	2x	1/1
00455	⑮	596*172*16	1x	1/1
00382	⑯	694*596*2,5	1x	1/1
00383	⑰	446*520*2,5	3x	1/1



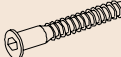
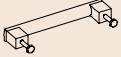

				
Ø1,6x20			Ø3,5x16	Ø4x16
C 30x	F 10x	M 4x	N 5x	P 4x

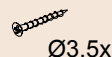
					
		Gb	Ø3,5x15		
A 12x	E 3x	G 6x	H 18x	I 24x	J 24x

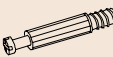

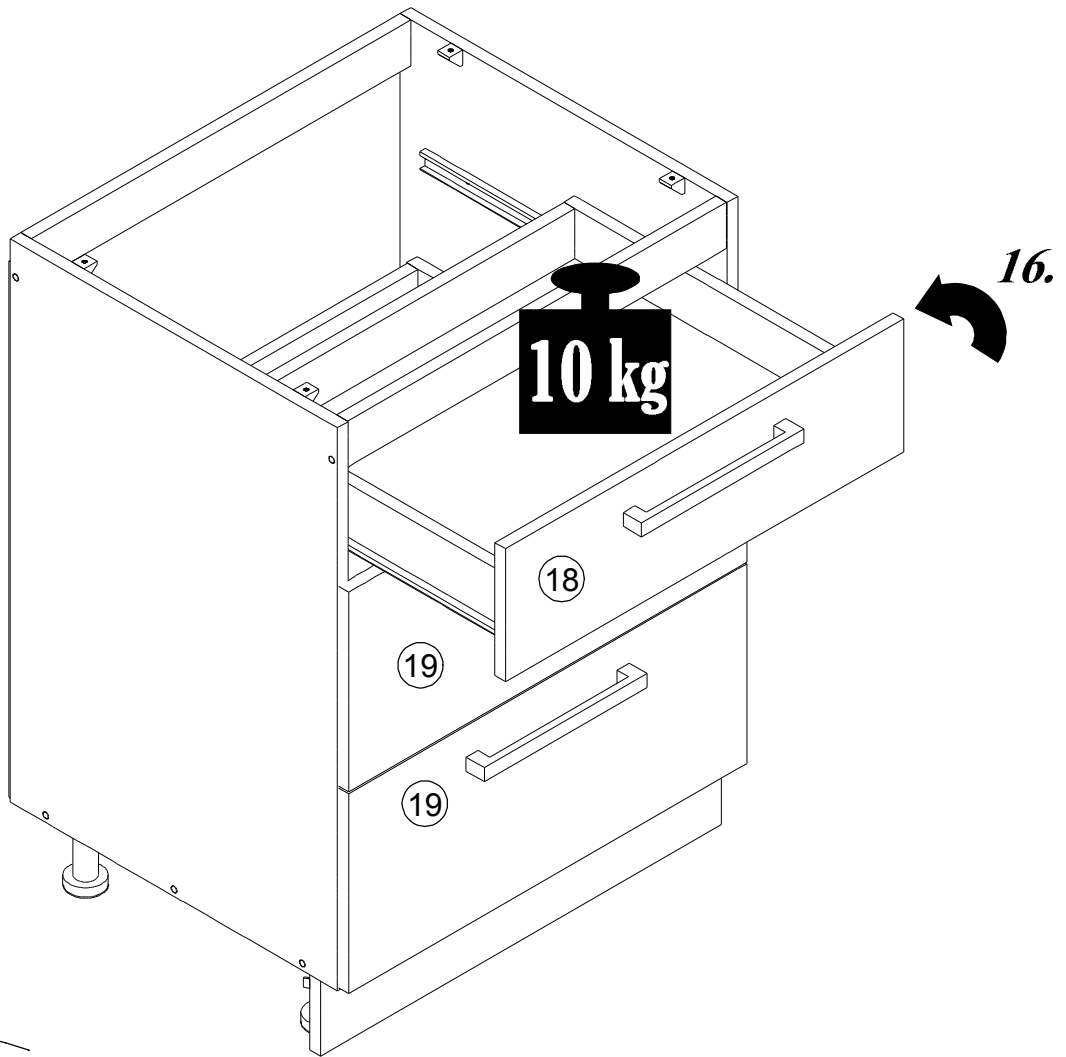
SK ŠABLÓNA  
 CZ ŠABLONA  
 HU SABLON  
 DE SCHABLONE

