

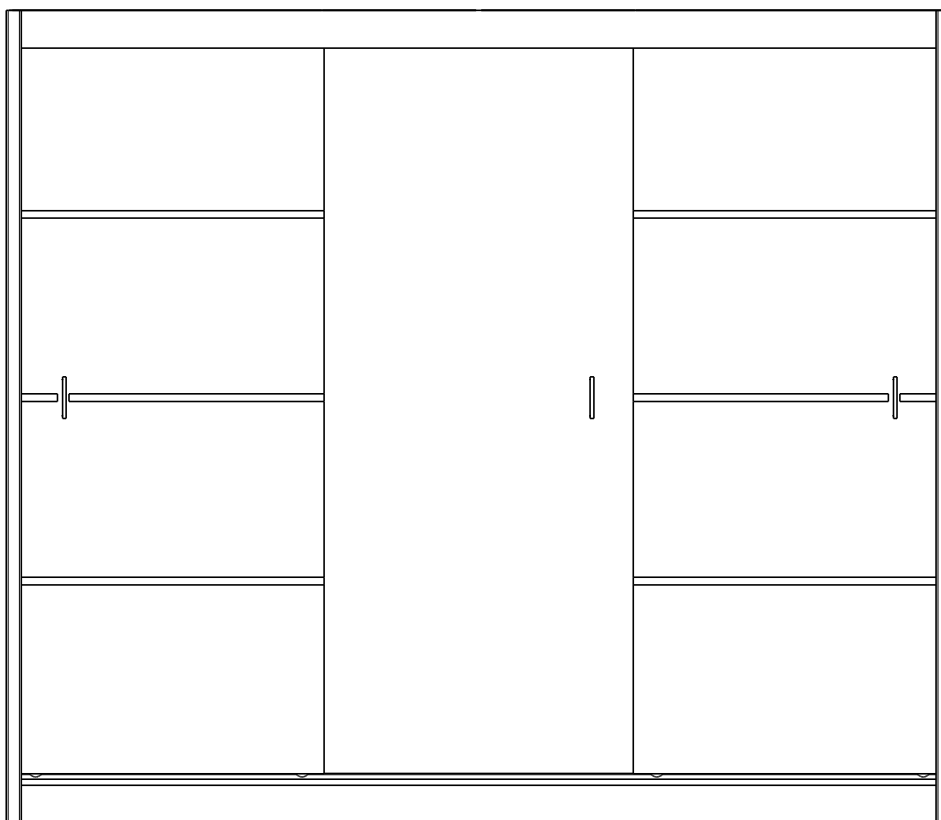









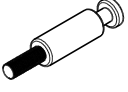

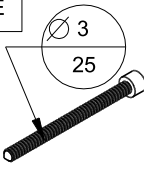
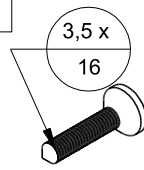
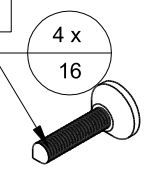
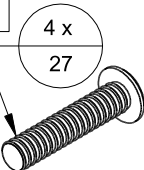
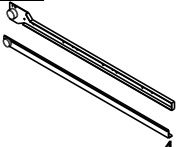
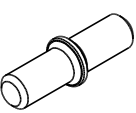

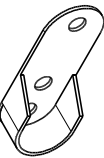
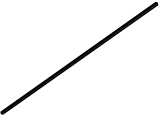
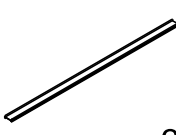

MERINA 250

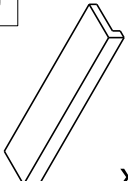
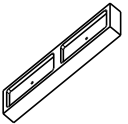

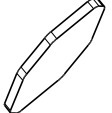
<p>A</p>  <p>x54</p>	<p>B</p>  <p>x8</p>	<p>C</p>  <p>x8</p>	<p>D</p>  <p>x36</p>	<p>E</p>  <p>$\varnothing 3$ 25</p> <p>x12</p>	<p>F</p>  <p>3,5 x 16</p> <p>x30</p>	<p>G</p>  <p>4 x 16</p> <p>x42</p>	<p>H</p>  <p>4 x 27</p> <p>x6</p>
<p>J</p>  <p>x4</p>	<p>K</p>  <p>x24</p>	<p>L</p>  <p>x1</p>	<p>M</p>  <p>x2</p>	<p>N</p>  <p>x2</p>	<p>P</p>  <p>x2</p>	<p>R</p>  <p>x12</p>	<p>S</p>  <p>x6</p>
<p>T</p>  <p>x6</p>	<p>U</p>  <p>x3</p>	<p>V</p>  <p>x10</p>	<p>W</p>  <p>x230</p>	<p>X</p>  <p>x10</p>	<p>Y</p>  <p>x2</p>	<p>Z</p> 	<p>AA</p> 

1

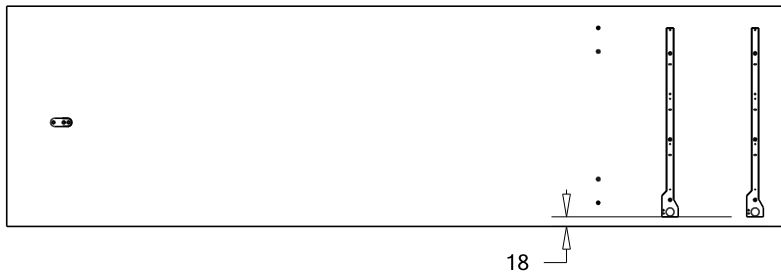
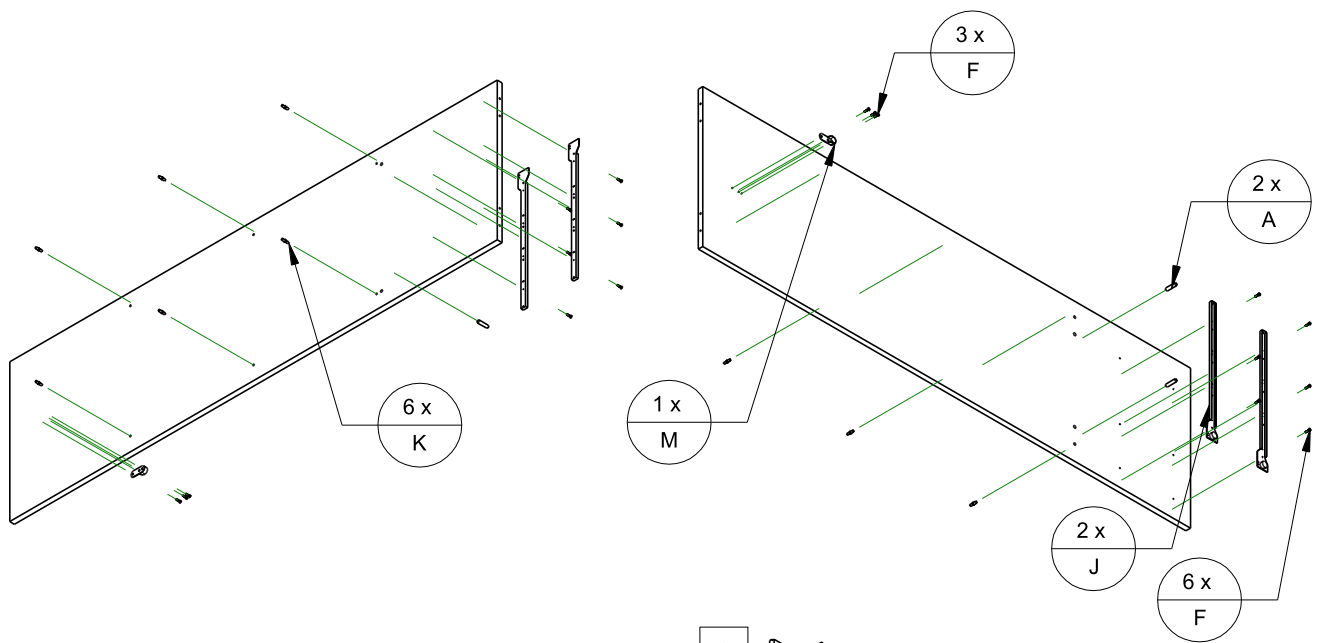

2

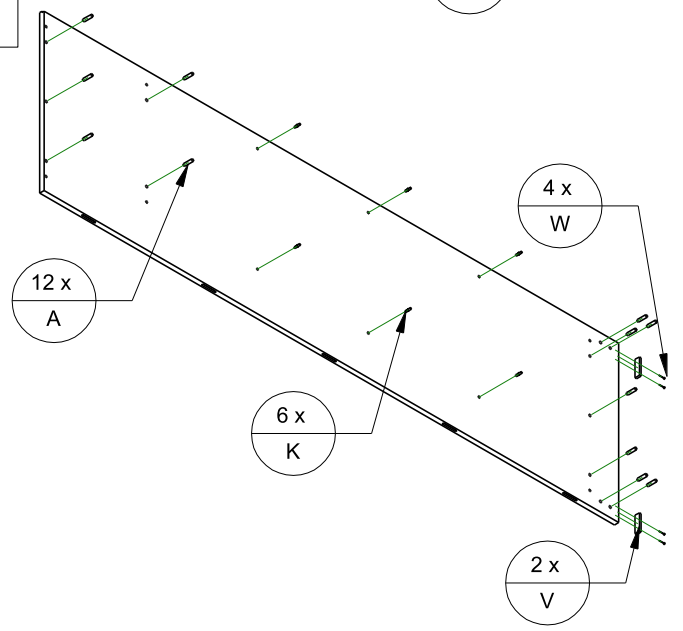

3

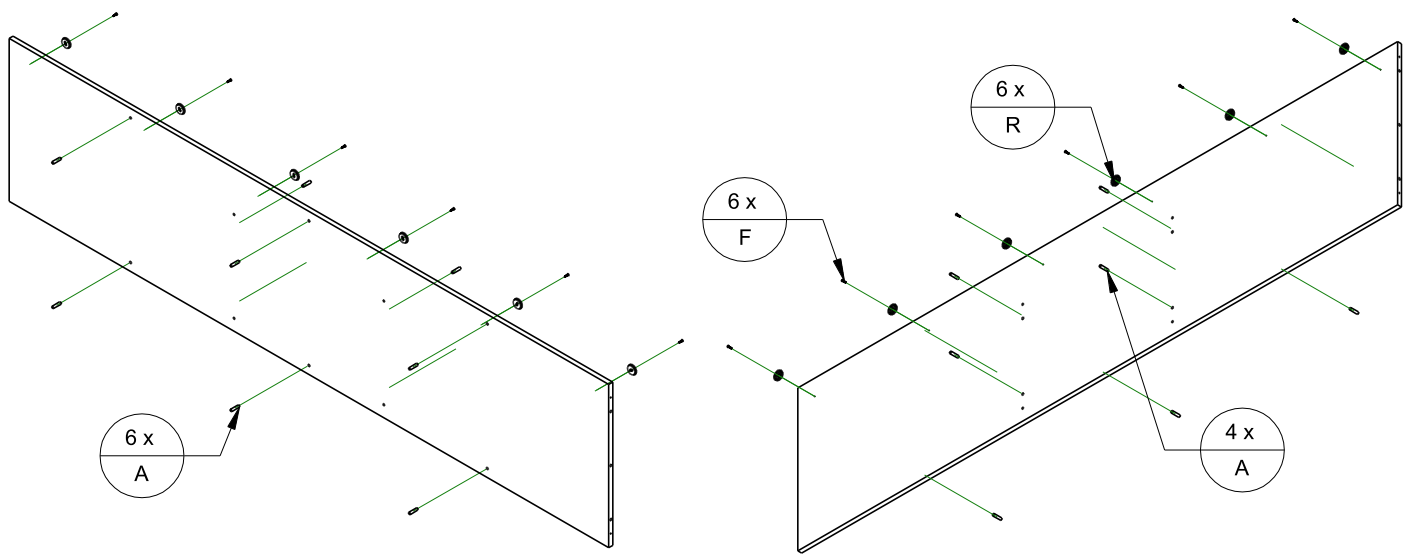

4

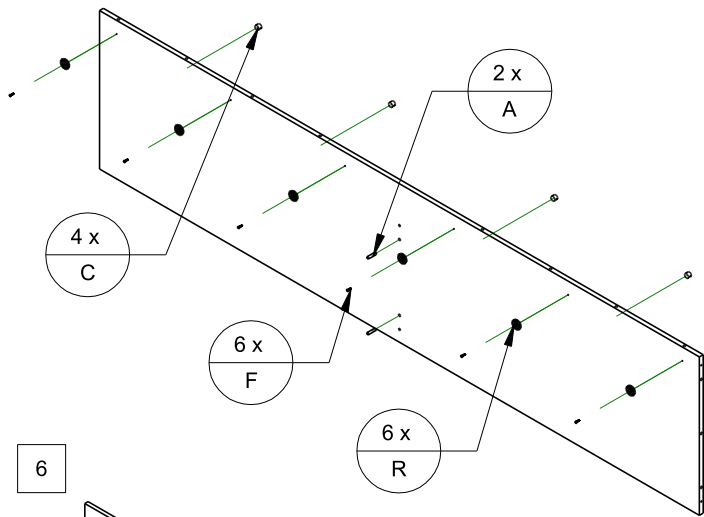

5

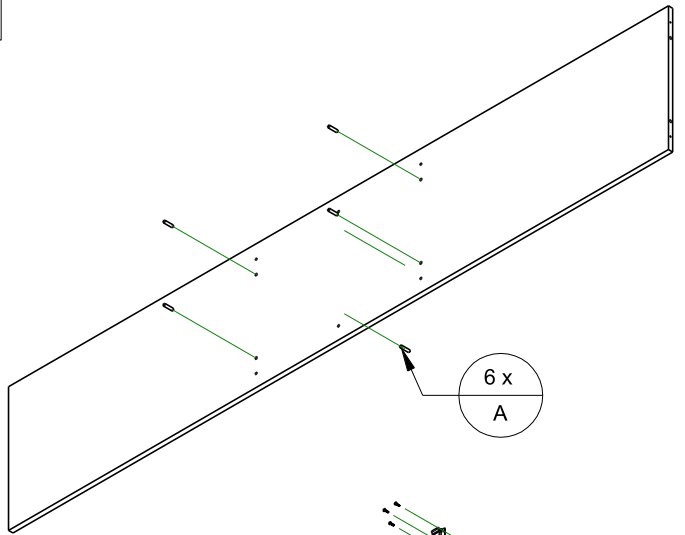

6

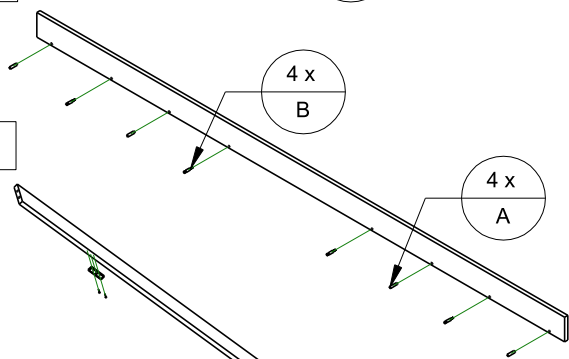

7

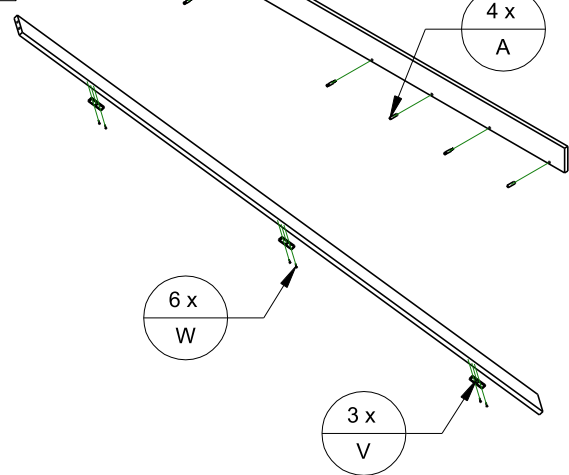

8

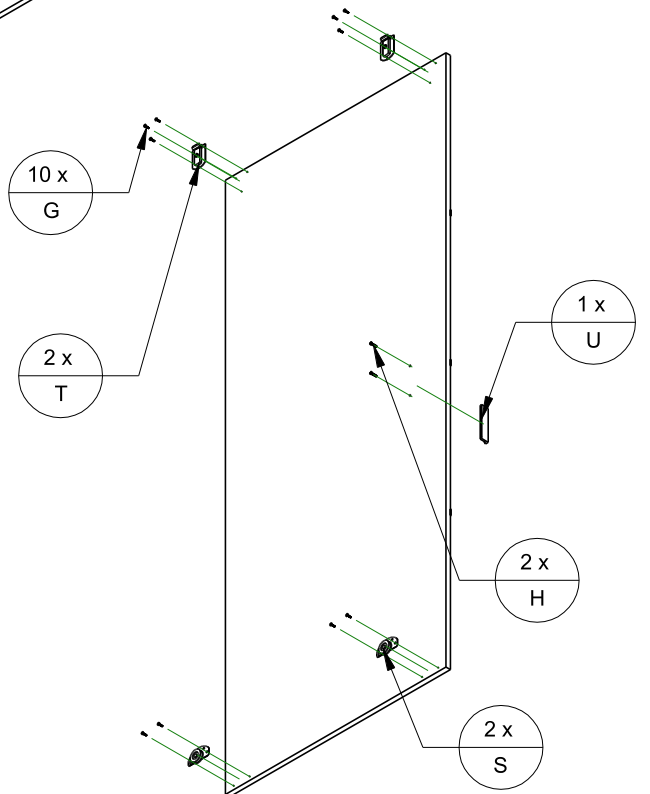

9

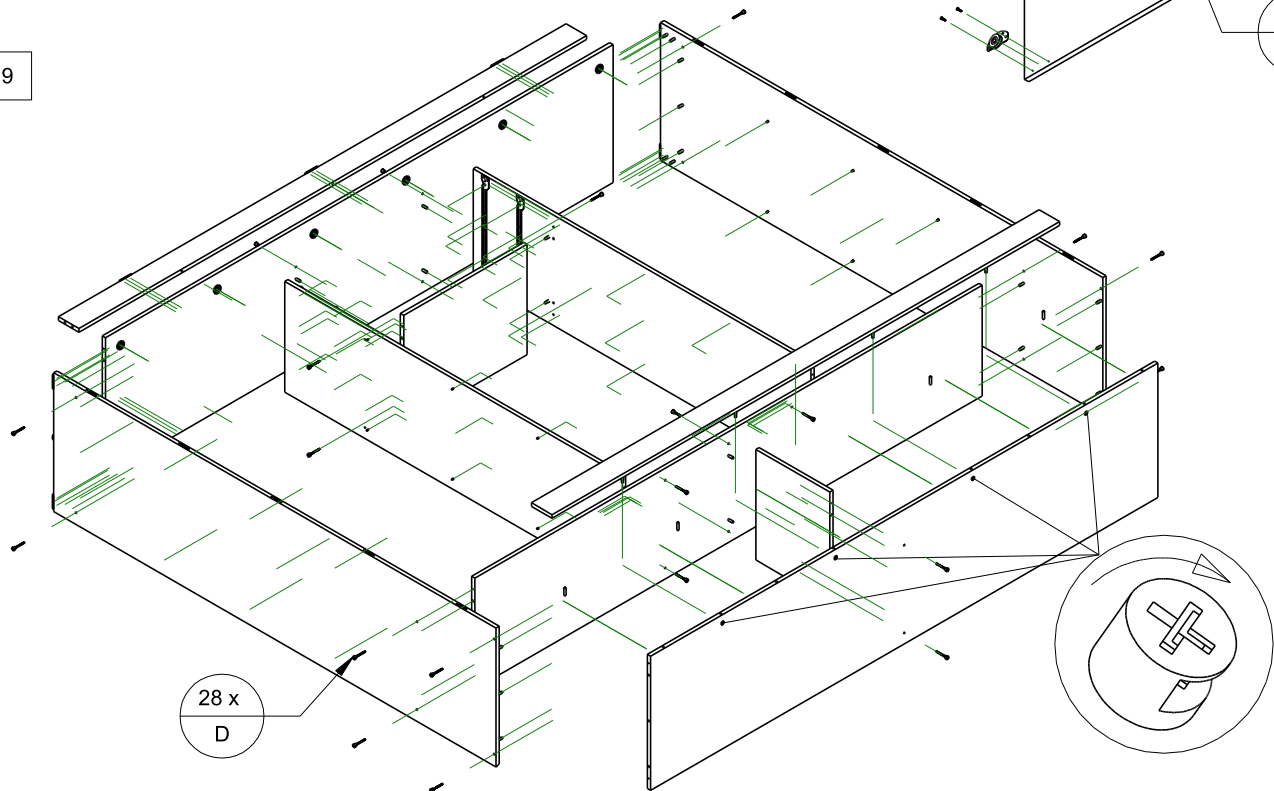

10

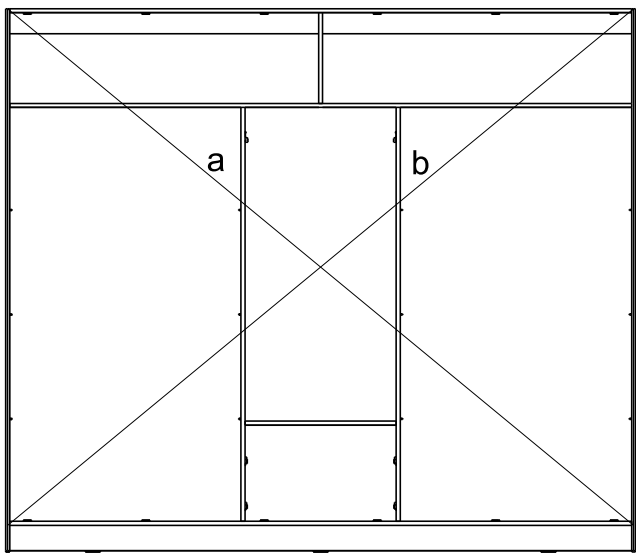

11

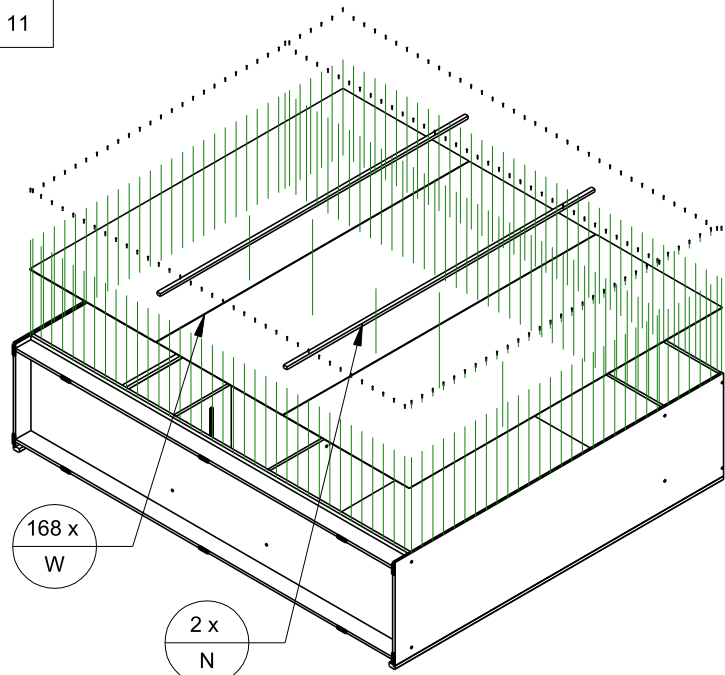

12

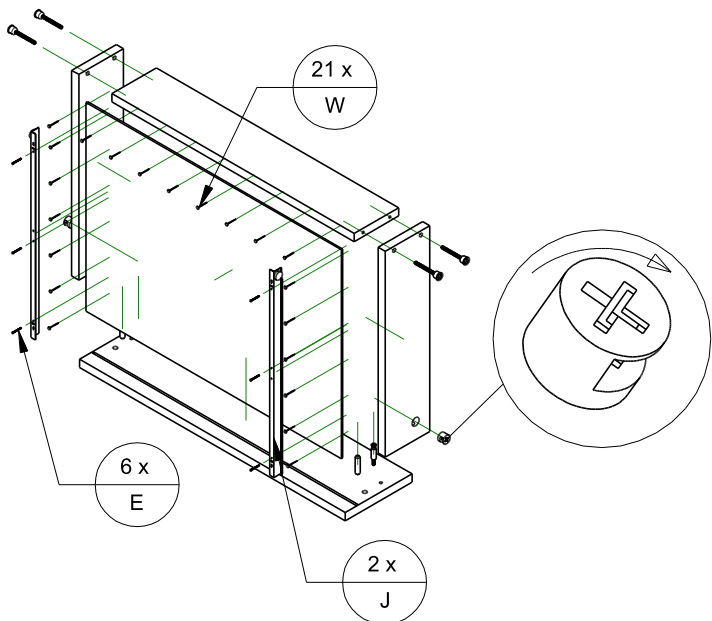
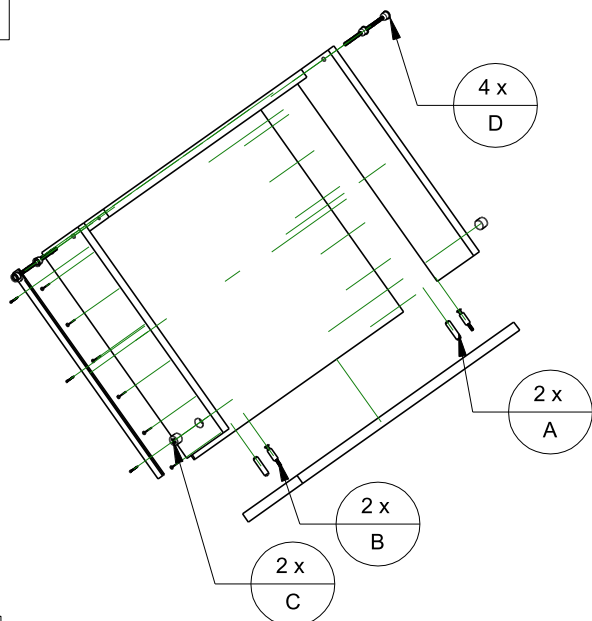

13

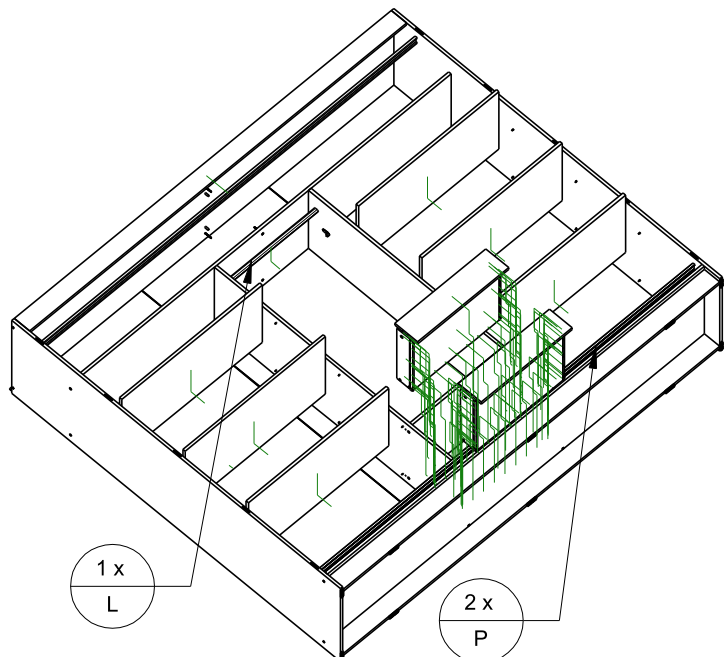

14

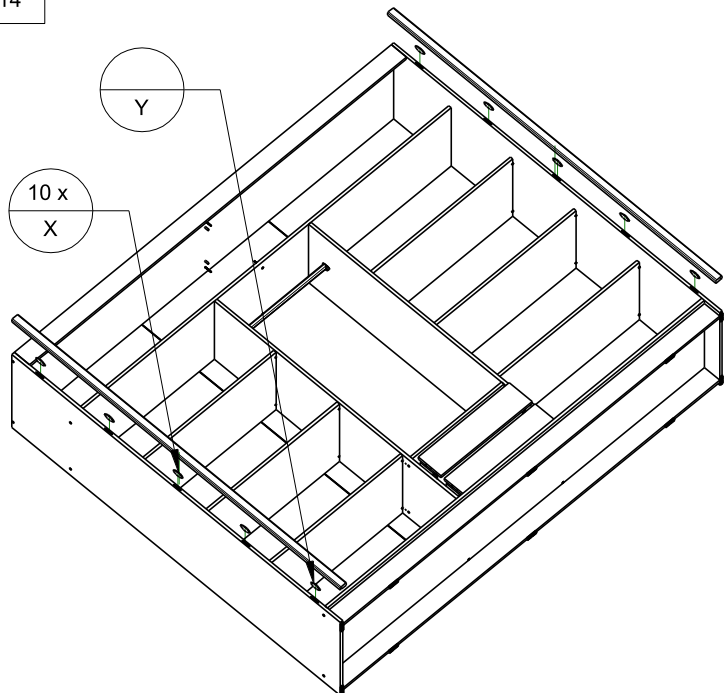

15

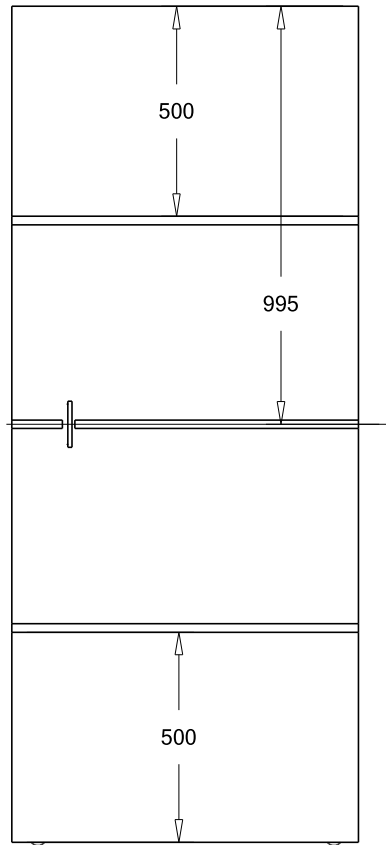
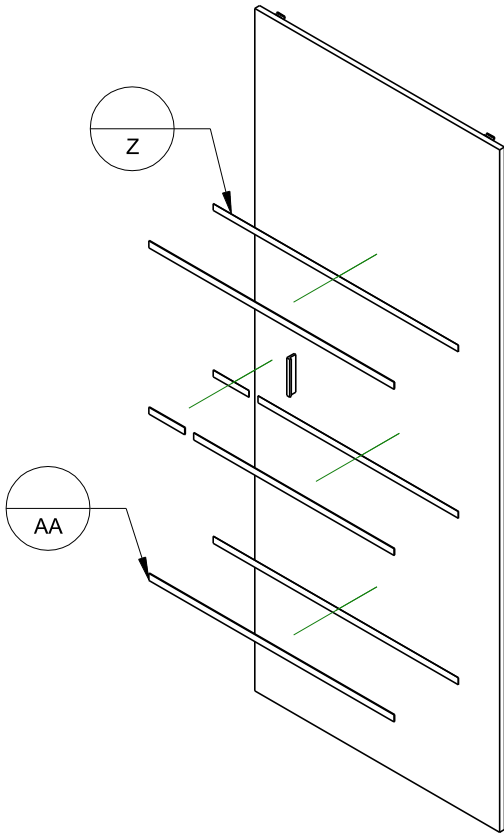

16

