

# montážny návod Emio

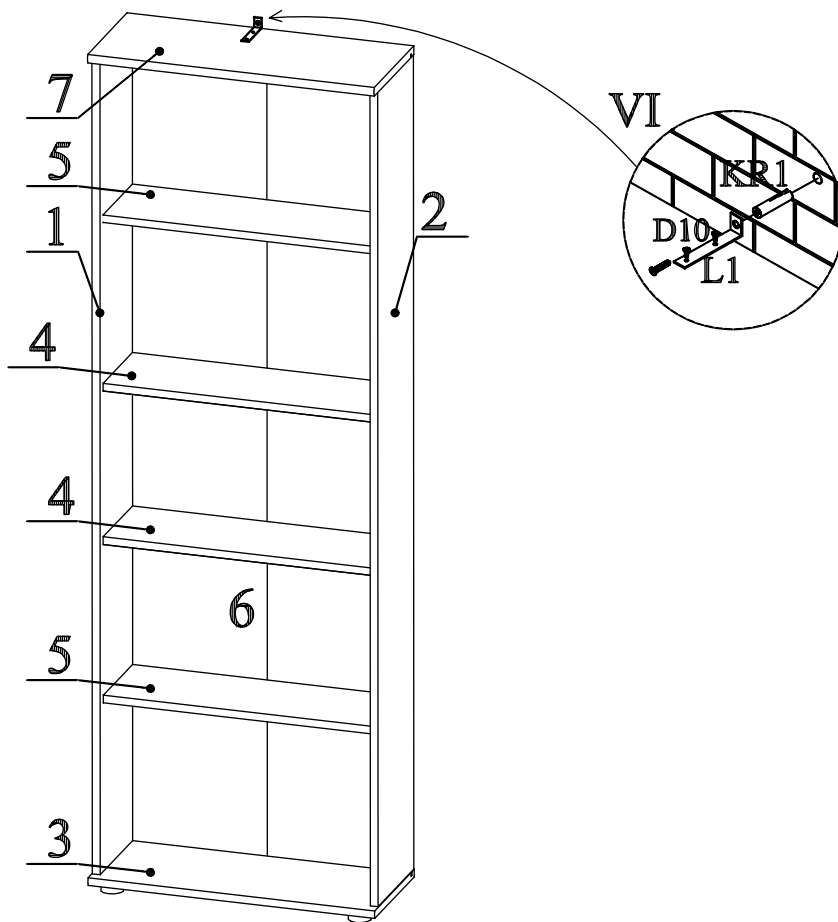





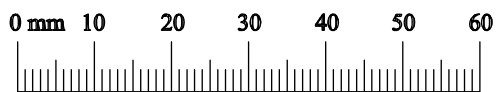
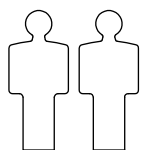

pred montážou prosíme preštudovať montážny návod

## regal typ 8

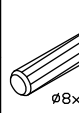
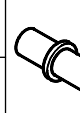
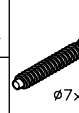
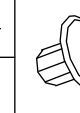
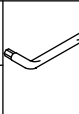

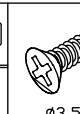
40 MIN

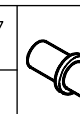

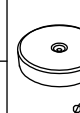
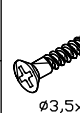
B5 ILOŠĆ 4  Ø15x12	L1 ILOŠĆ 1 	B4 ILOŠĆ 4  Ø5x13	A1 MENGE 16  Ø8x36	G7 ILOŠĆ 8 	B11 ILOŠĆ 4  Ø7x50	G4 MENGE 4 
G2 MENGE 1 	S1 ILOŠĆ 12 	KR1 ILOŠĆ 1 	D10 ILOŠĆ 2  Ø3,5x13	G5 ILOŠĆ 4 	G7 ILOŠĆ 8 	
B3 ILOŠĆ 10  Ø1,4x25	I11 ILOŠĆ 4  Ø45	D11 ILOŠĆ 4  Ø3,5x25				

# regal typ 8

**I**

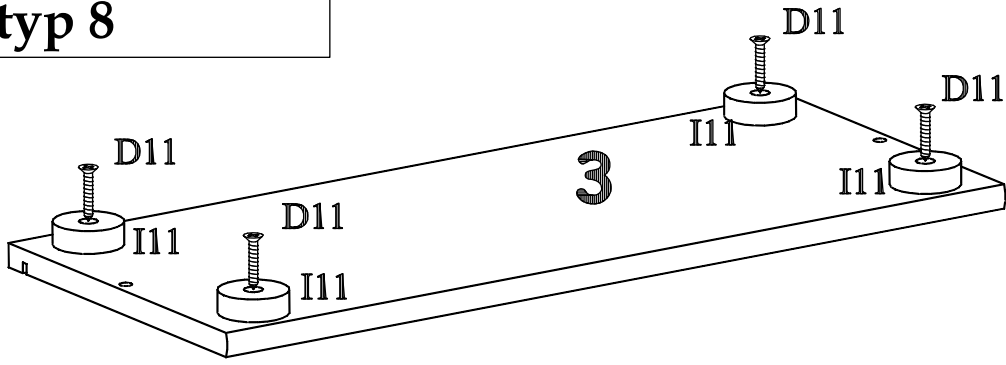

**II**

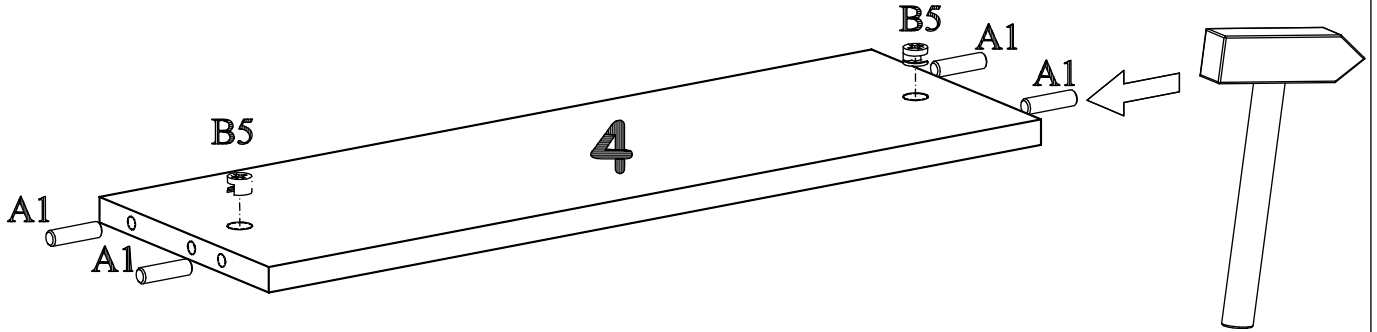

**III**

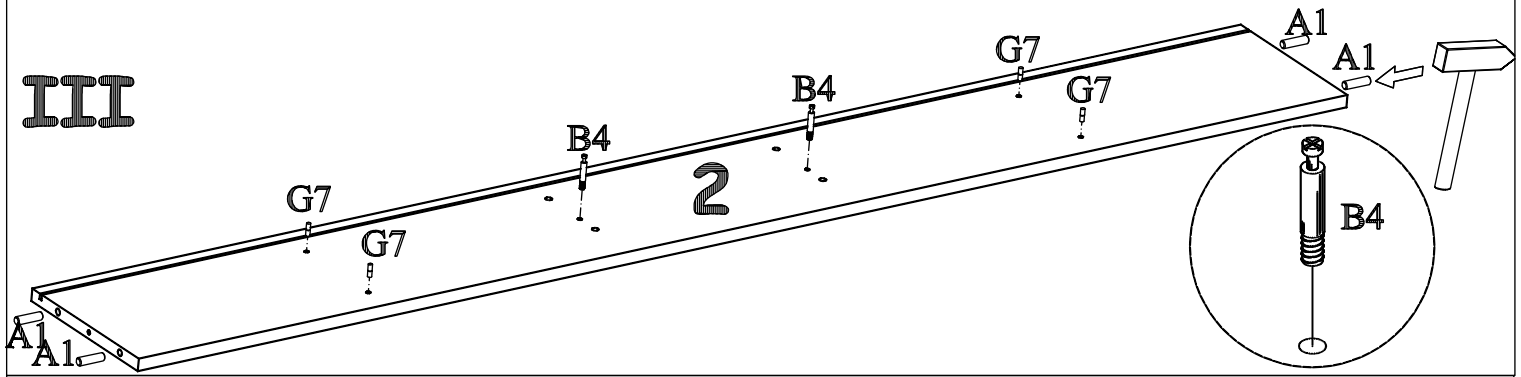

**IV**

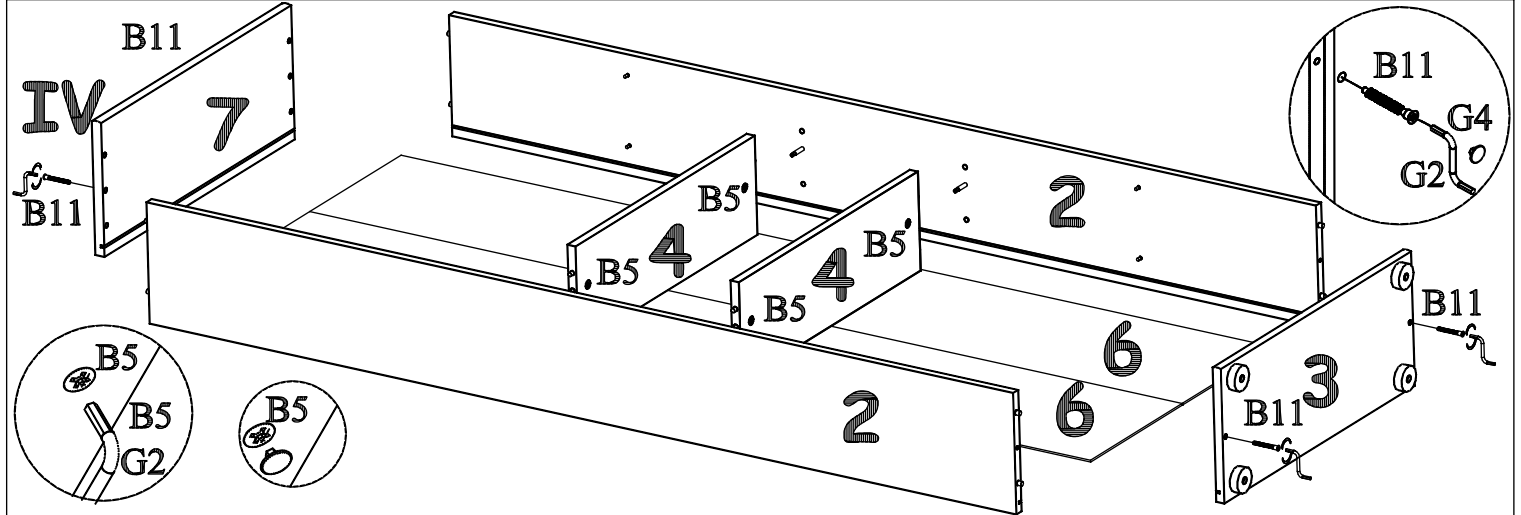

**V**

