

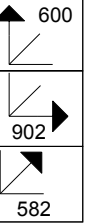

BETTY 04  
**BE04-004-00**



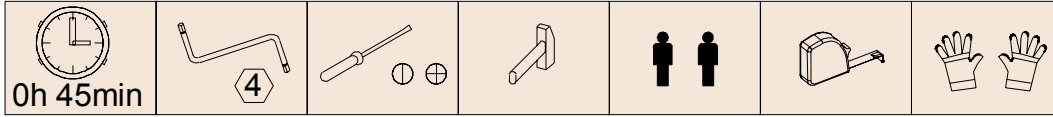

V PRÍPADE REKLAMÁCIE JE POTREBNÉ NAHLÁSIŤ  
 VÝROBNÉ ČÍSLO VIDITEĽNÉ NA ETIKETE

A 8x	B 8x	C 4x	D 20x	E 2x	F 4x	G 4x	H 8x	J 2x	P 8x

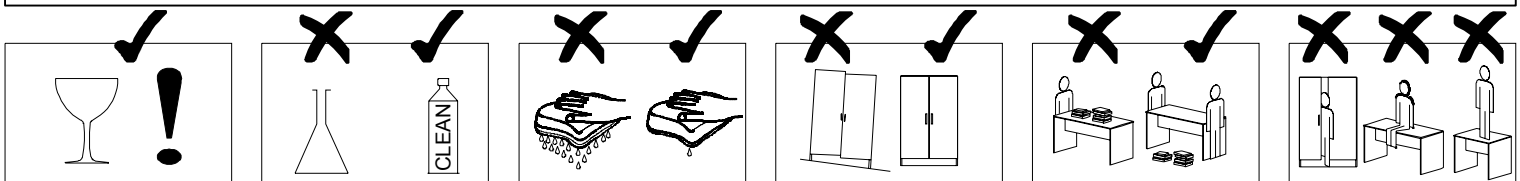
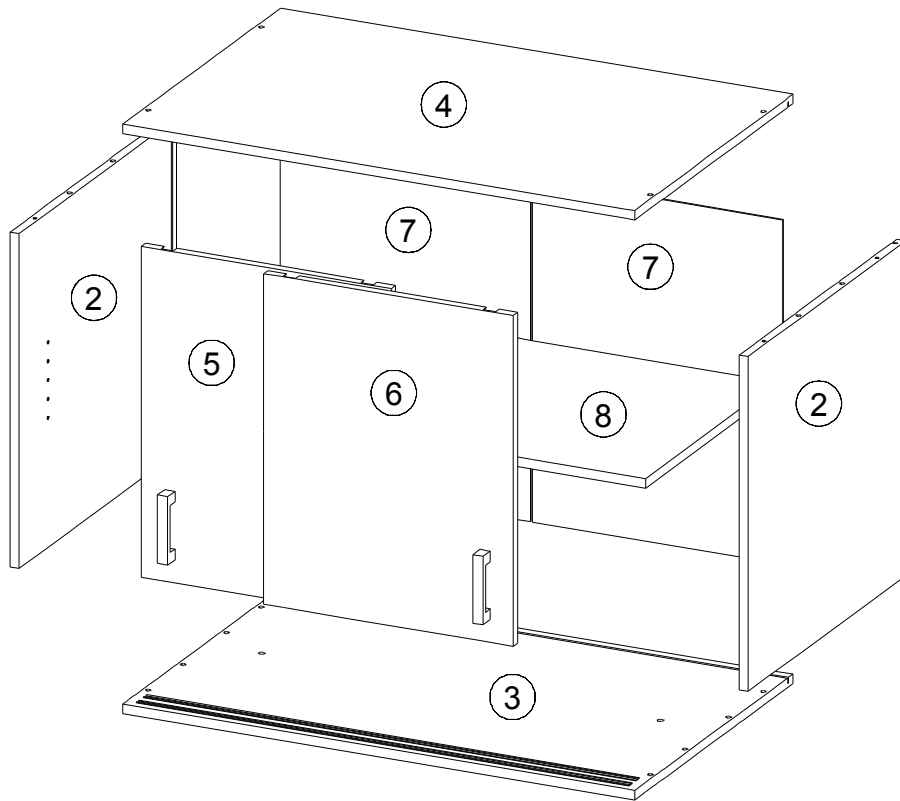
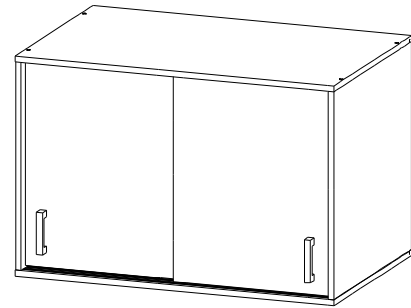

ID	ID	Part	Qty	Unit
01719	②	568*580*16	2x	1/1
01700	③	902*582*16	1x	1/1
01720	④	902*582*16	1x	1/1
01721	⑤	561*440*16	1x	1/1
01722	⑥	561*440*16	1x	1/1
01723	⑦	584*442*2,5	2x	1/1
01724	⑧	867*485*16	1x	1/1

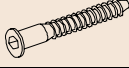

			
A	4x	B	8x

